

MAV4211 ELECTRONIC MODULE FOR INTEGRATED CONTROL OF PROPORTIONAL VALVES

MAV4211: Electronic module for integrated control of proportional valves, bankable valves and proportional directional valves HPV.

The MAV4211 controller unit is used for the control of proportional solenoids and additional switching functions. The proportional solenoid outputs are pulse-width-modulated (PWM) and optimally adapted for electric proportional control. The switched outputs are designed for the direct switching of relays, lamps and switching solenoids. The MAV unit can managed up to 4 analog input signal and 8 PWM current output (4 PWM current output simultaneous, max load 9Amperes).

The RS232 serial interface and BPE software tool enables the connection of PC for service functions, such as diagnostics, parameter setting or display of process variables.

European norms: EN 61000 - ElectroMagnetic Compatibility (EMC) - industrial environment

MAV4211

LAYOUT	CAP. IX • 24
ELECTRICAL CONNECTINS	CAP. IX • 24
OVERALL DIMENSIONS	CAP. IX • 24
MOUNTING EXAMPLE	CAP. IX • 25

Optional (on request):

- on/off output for venting valve on CAT 3 safety

Adjustment parameters by RS232 link :

Frequency PWM

Offset current

Gain current

Ramp up time current

Ramp down time current

Analog input configuration (voltage 0.5 ÷ 4.5V, 1 ÷ 9V, current 4 ÷ 20mA).

ORDERING CODE

Code	Description
7.365.1043	MAV4211 electronic module for integrated control of proportional valves
www.bpe.it	BPE Terminal software downloaded from www.bpe.it website

SPECIFICATIONS:

Nominal voltage		12V and 24V
Operating supply voltage		9 ÷ 33Vdc
Current consumption	With load, max	9A
Protection Fuse	External	Rapid fuse 10A
Constant voltage source	For joystick supply	5V
Analog input selectable by serial link	Voltage	0.5 ÷ 4.5V
	Voltage	1 ÷ 9V
	Current	4 ÷ 20mA
Switch input	High or low active	Low < 1.5V; high > 6V
Proportional PWM output		0 ÷ 2A
PWM frequency range		70Hz ÷ 250Hz
On/off output (mosfet)		3A
Led indicator		Green/red/yellow
Interfaces		RS232 e CAN 2.0B
Number of analog input		4
Number of switch input		1
Number of PWM output		8
Number on/off output	For venting valve	1
Protezione da cortocircuito	Ingresso ed uscite	Yes
Protection against short circuit		Yes
Operating temperature		-40 ÷ 70°C
IP protection	With mounted mating connector	IP67
Mating connector	FCI - SICMA	24 pole

MAV product must be used with joysticks JCFD1GG1 output signal 10-90% or similar.

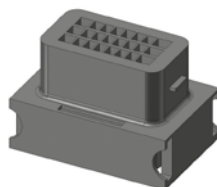

Plug-in connector 24 poles FCI - SICMA (to be ordered separately)

Code	Description
7.003.054	Connector
7.180.403	Connector with 1 mt. cable length

MAV4211 ELECTRONIC MODULE

LAYOUT

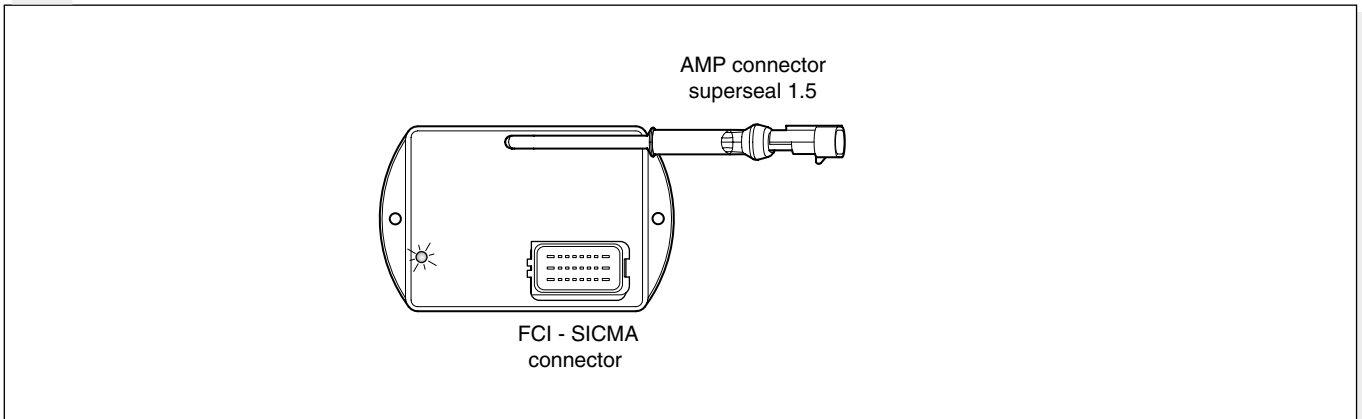

ELECTRICAL CONNECTINS

Contacts description MAV4211: Mating Connector FCI - SICMA

PIN	8	7	6	5	4	3	2	1
A	On/off output	Return PWM 4 A AND B	Return PWM 1 A AND B	PWM out 2B A AND B	CAN_H	PWM out 4B	PWM out 4A	+ Supply
B	PWM out 1B	Return PWM 3 A and B	Return PWM 2 A and B	Switch input 1	Analog input 1	Analog input 3	PWM out 3B	PWM out 3A
C	PWM out 2A	5V joystick supply	PWM out 1A	Not used	Analog input 2	Analog input 4	CAN_L	- Supply

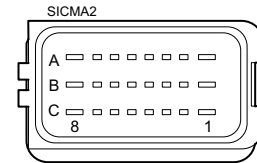

Serial Link RS232 connector : AMP superseal 1.5

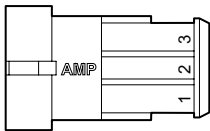

PIN 1	PIN 2	PIN 3
GND	RX	TX

Connection example:

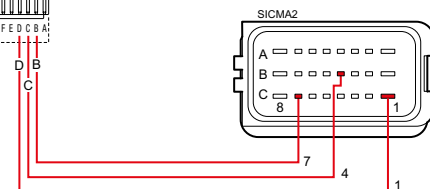
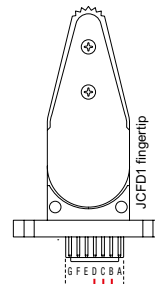
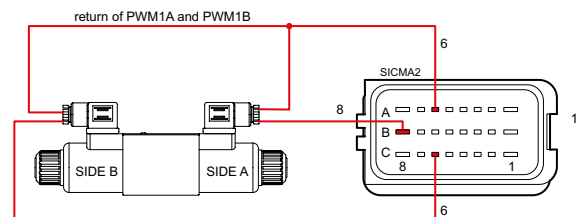

9

OVERALL DIMENSIONS

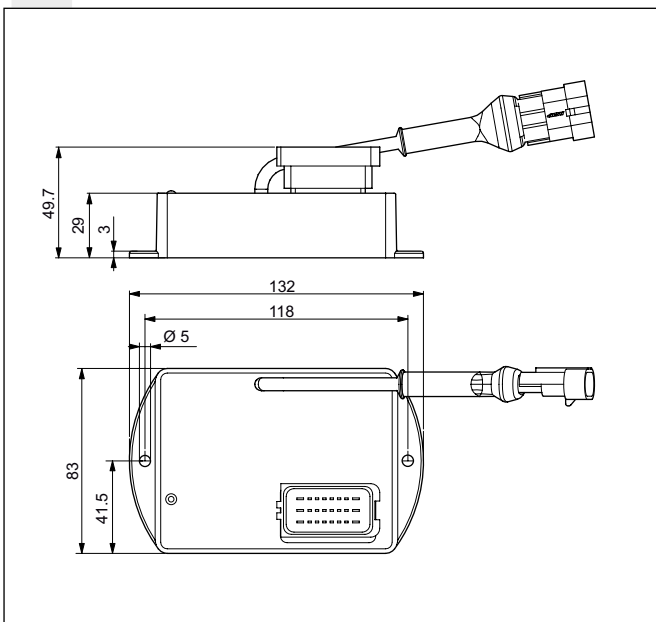

MOUNTING EXAMPLE WITH DANA BREVINI PRODUCTS

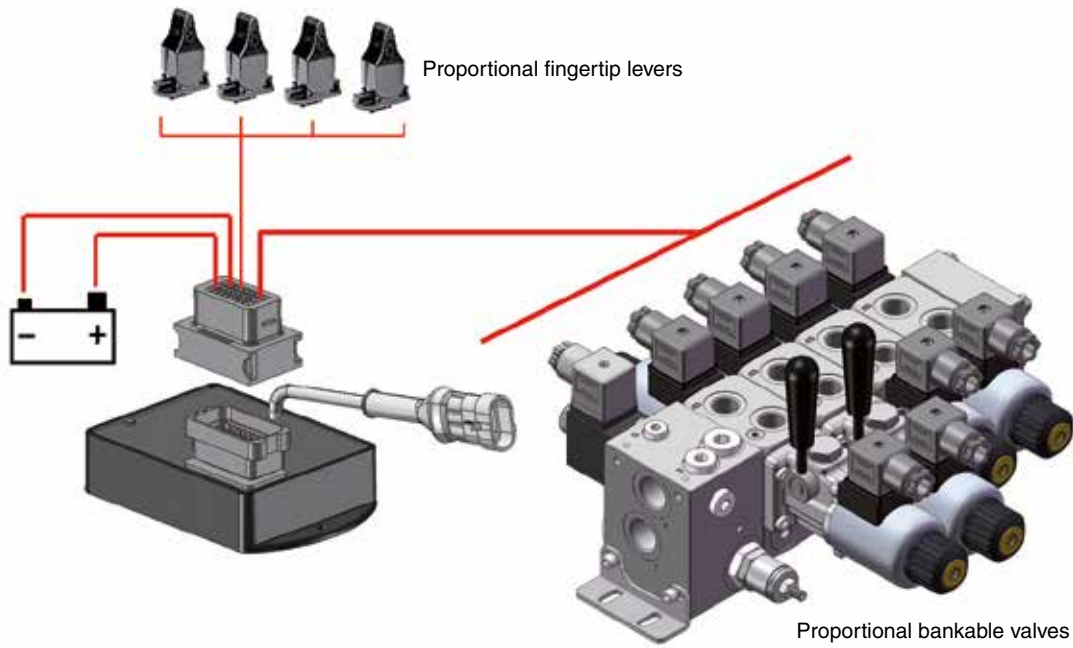

NOTE: MAV product must be used with joysticks JCFD1GG1 output signal 10-90% or similar.

